

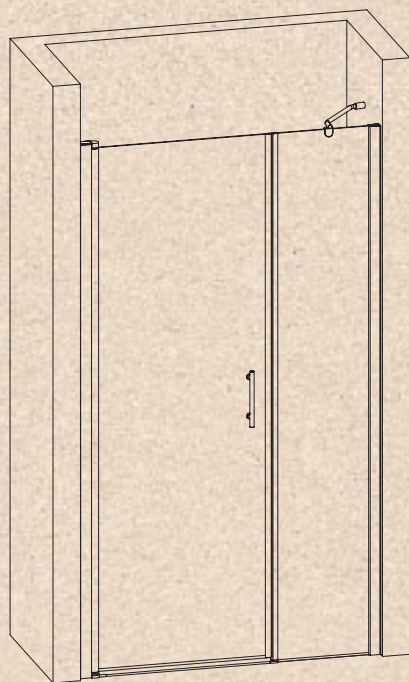

deante
pokieruj wodą

**INSTRUKCJA
MONTAŻU DRZWI
MOON**

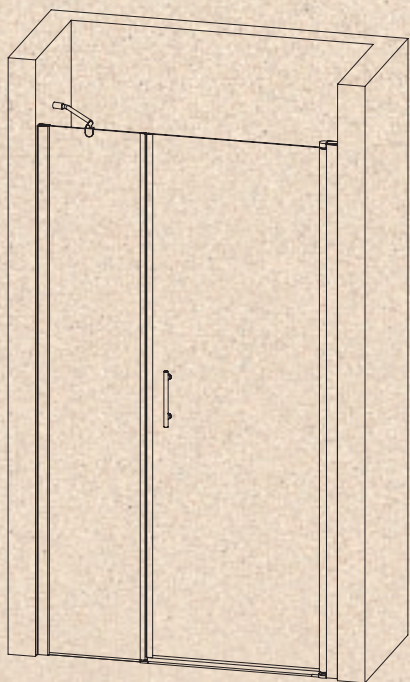

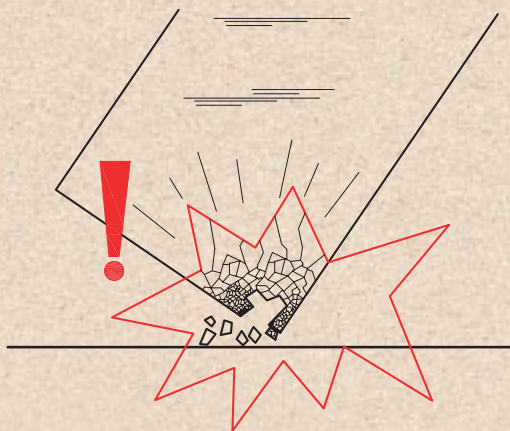
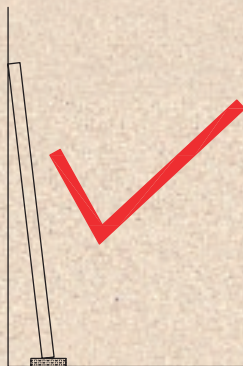
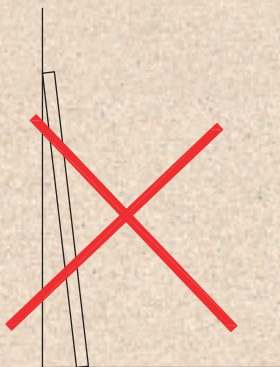

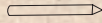
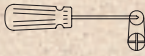
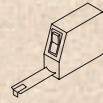
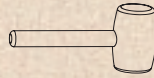
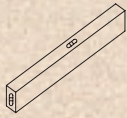

Ø6

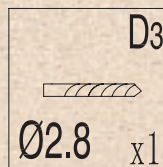
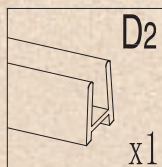
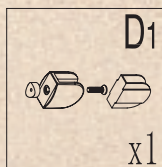
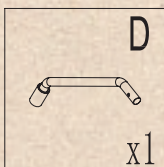
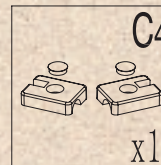
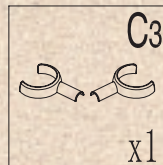
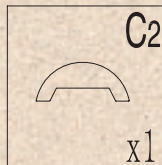
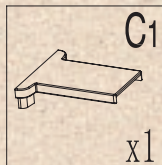
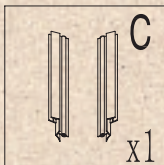
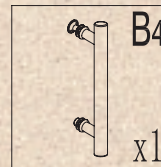
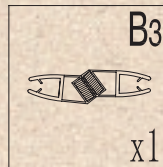
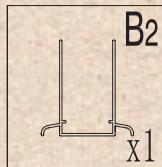
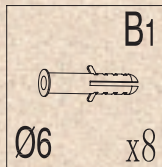
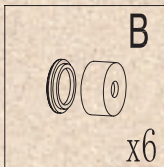
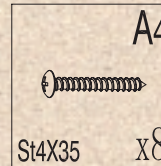
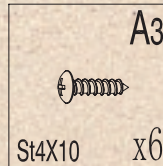
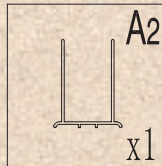
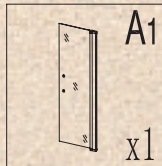
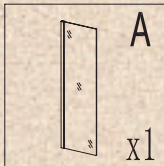

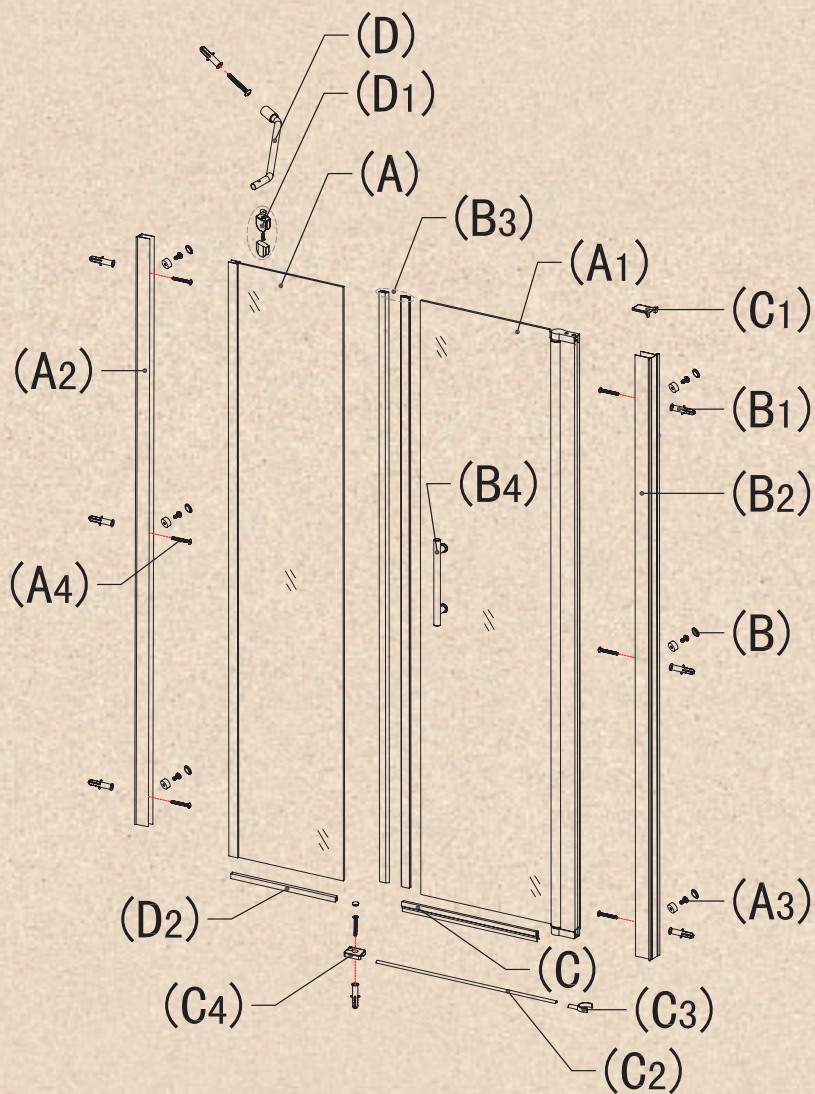

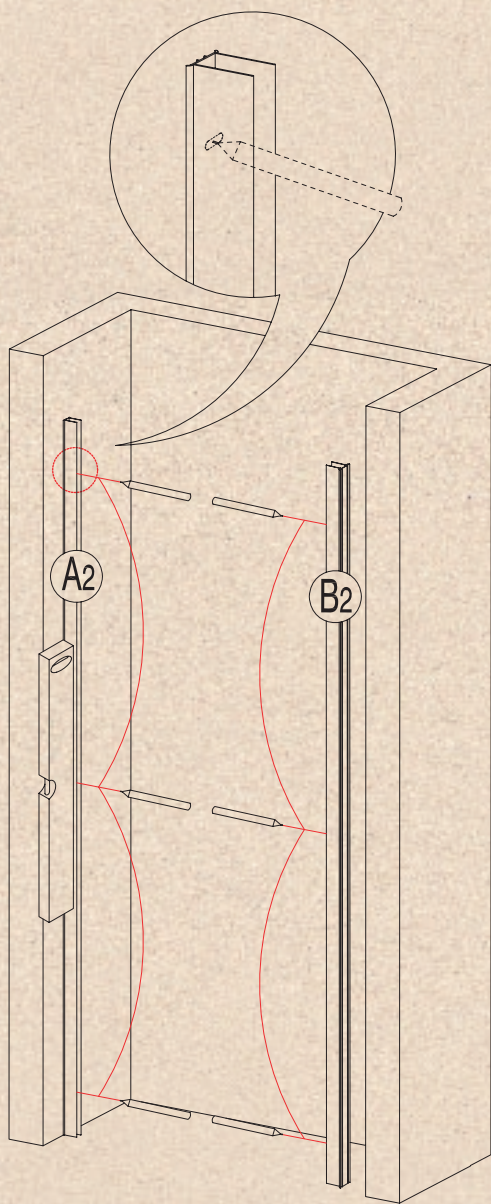

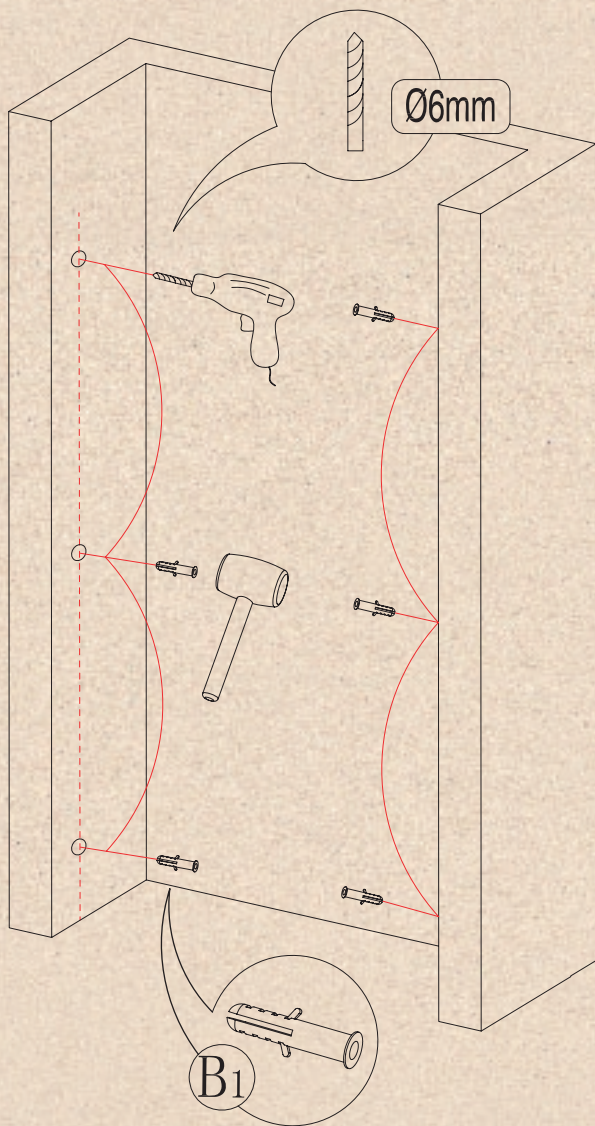

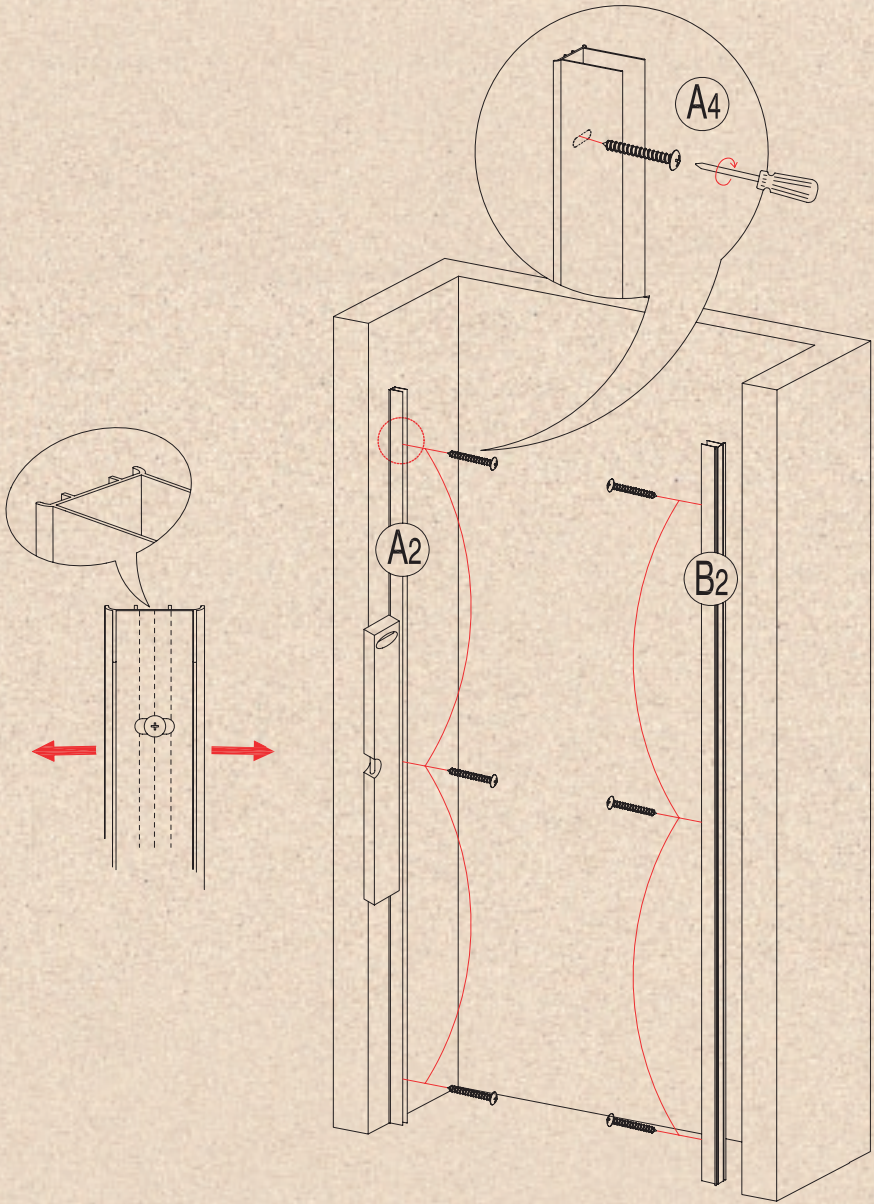

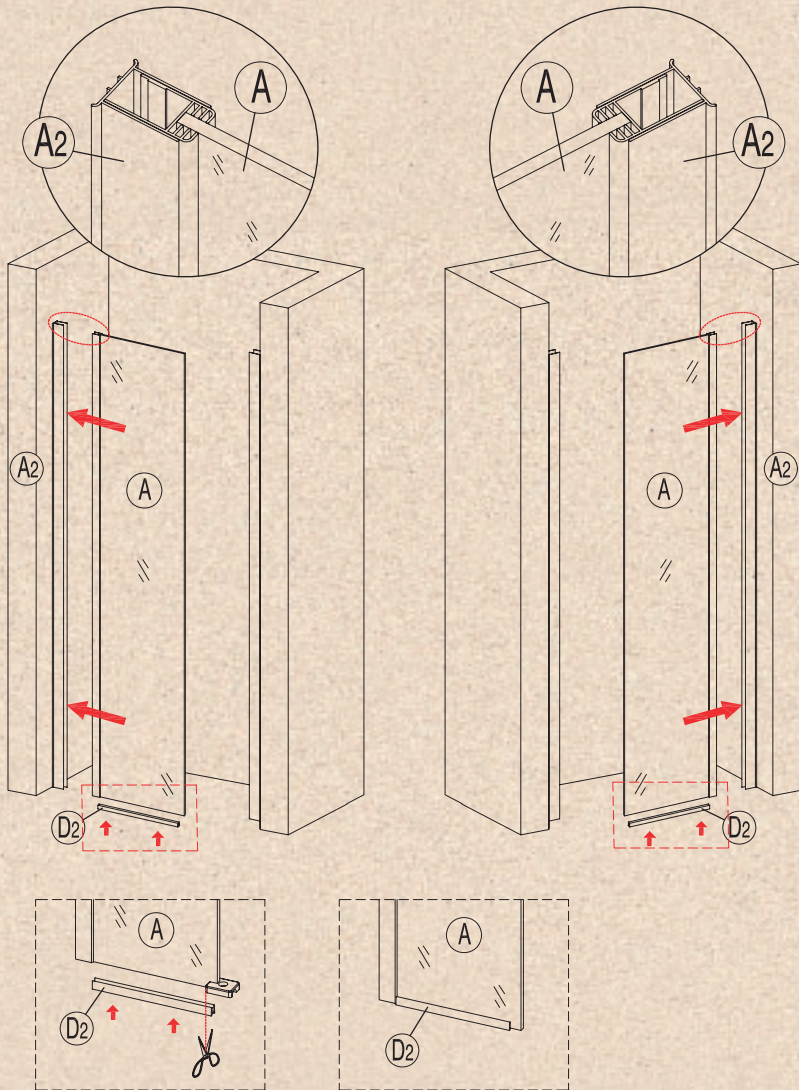

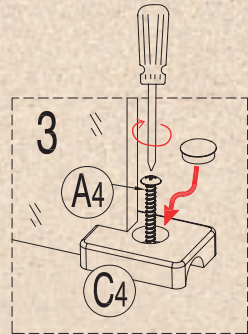
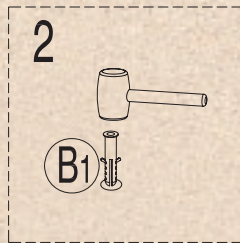
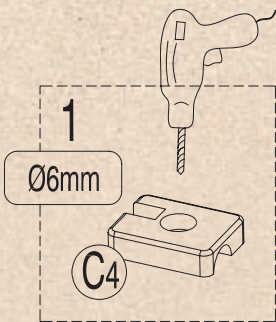
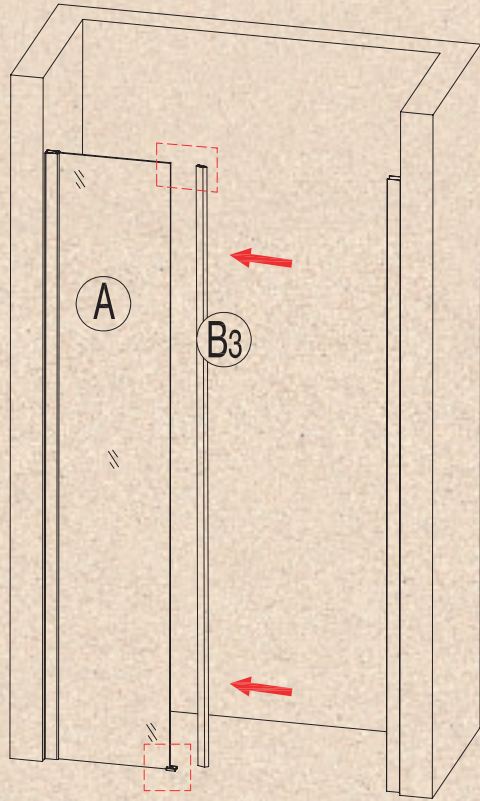
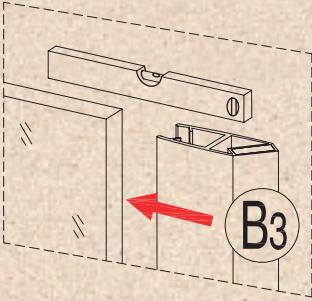

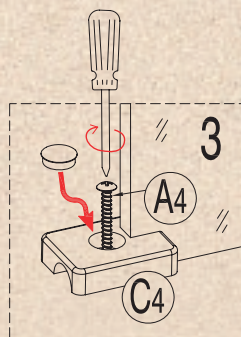
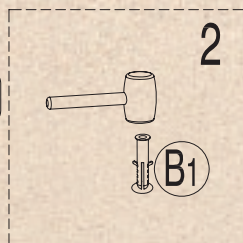
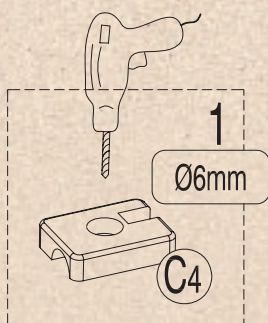
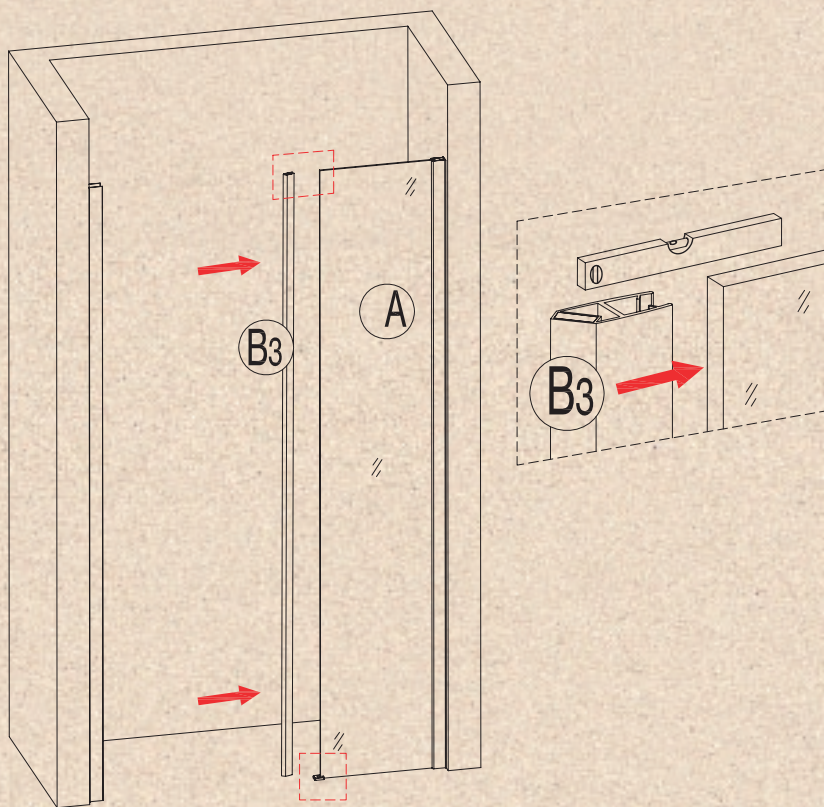

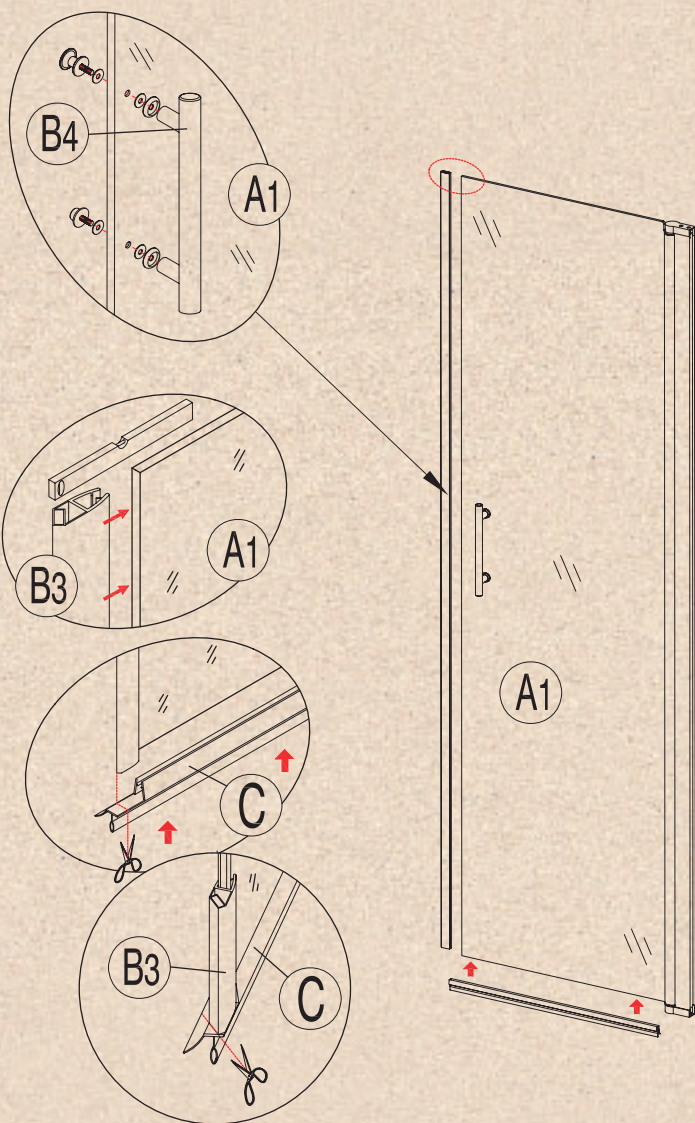

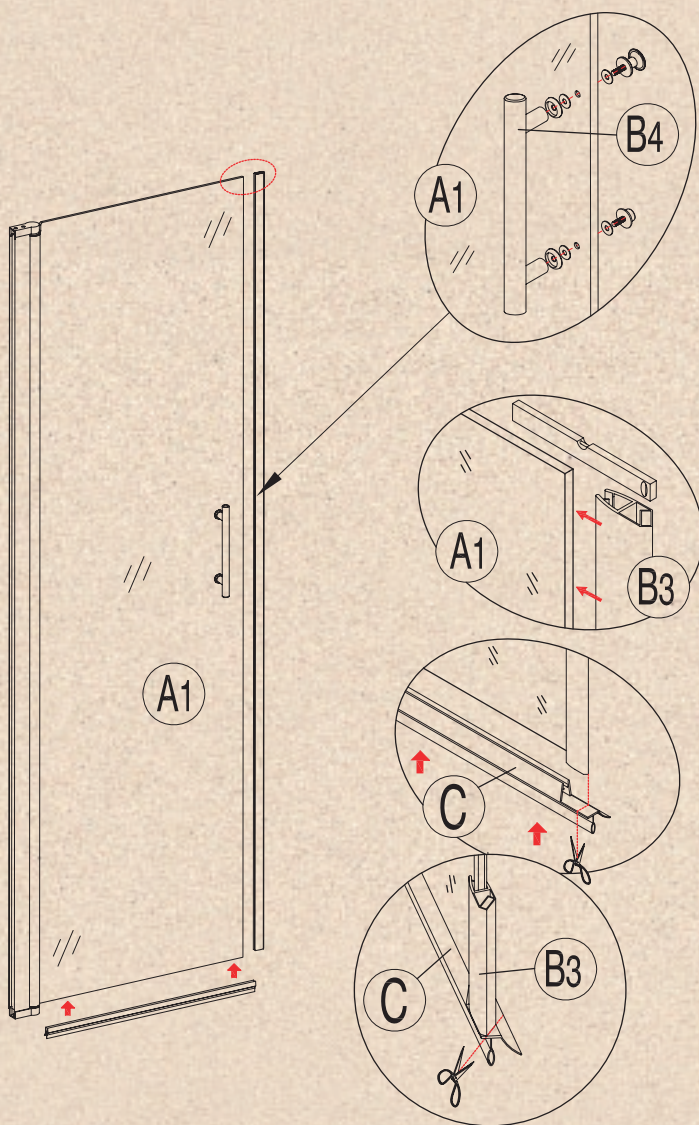

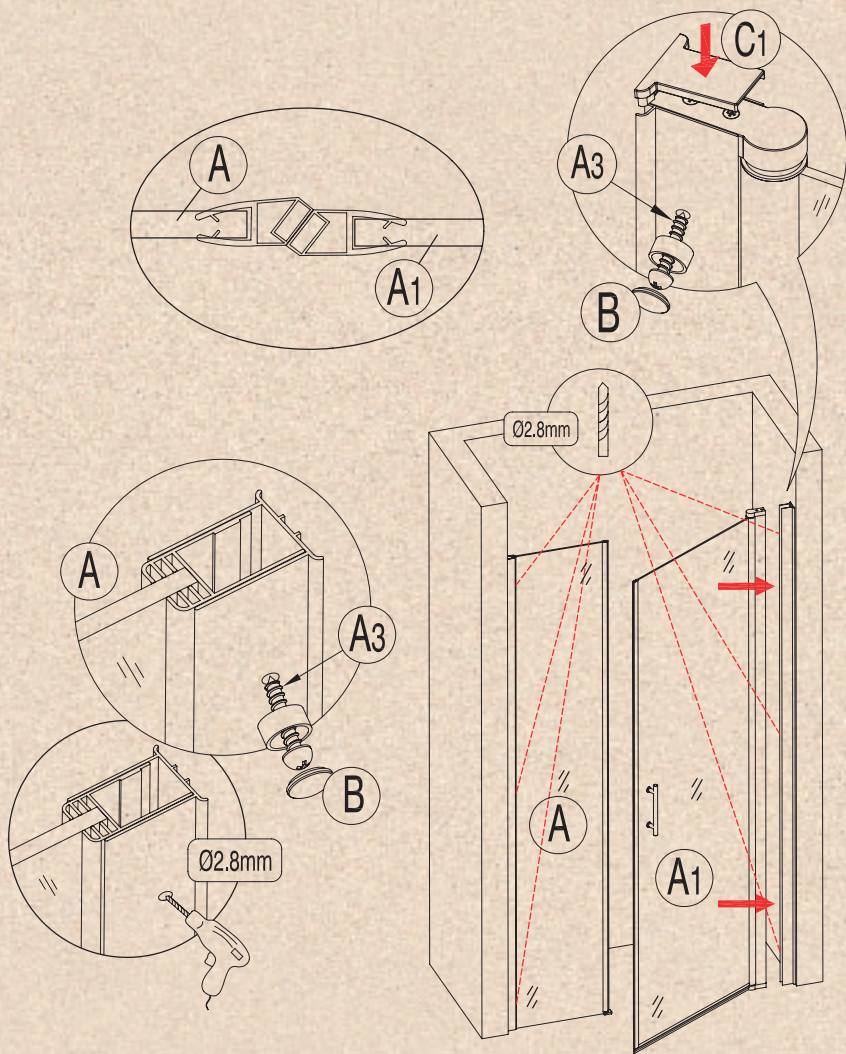

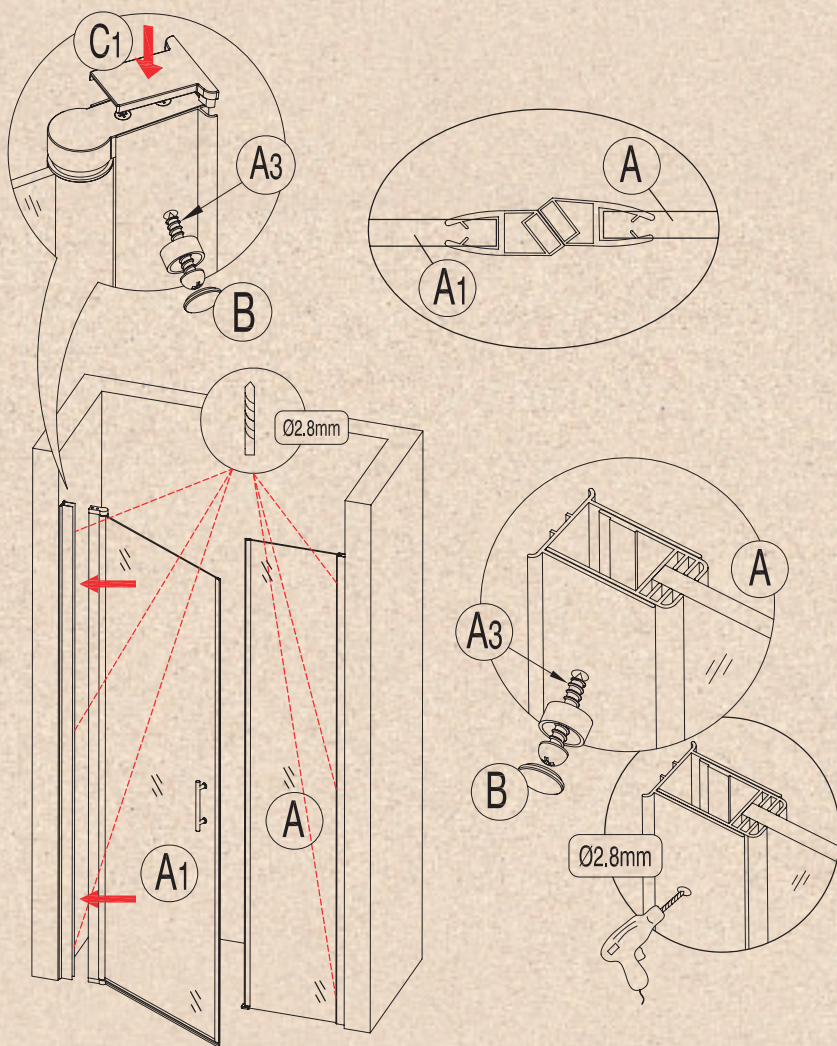

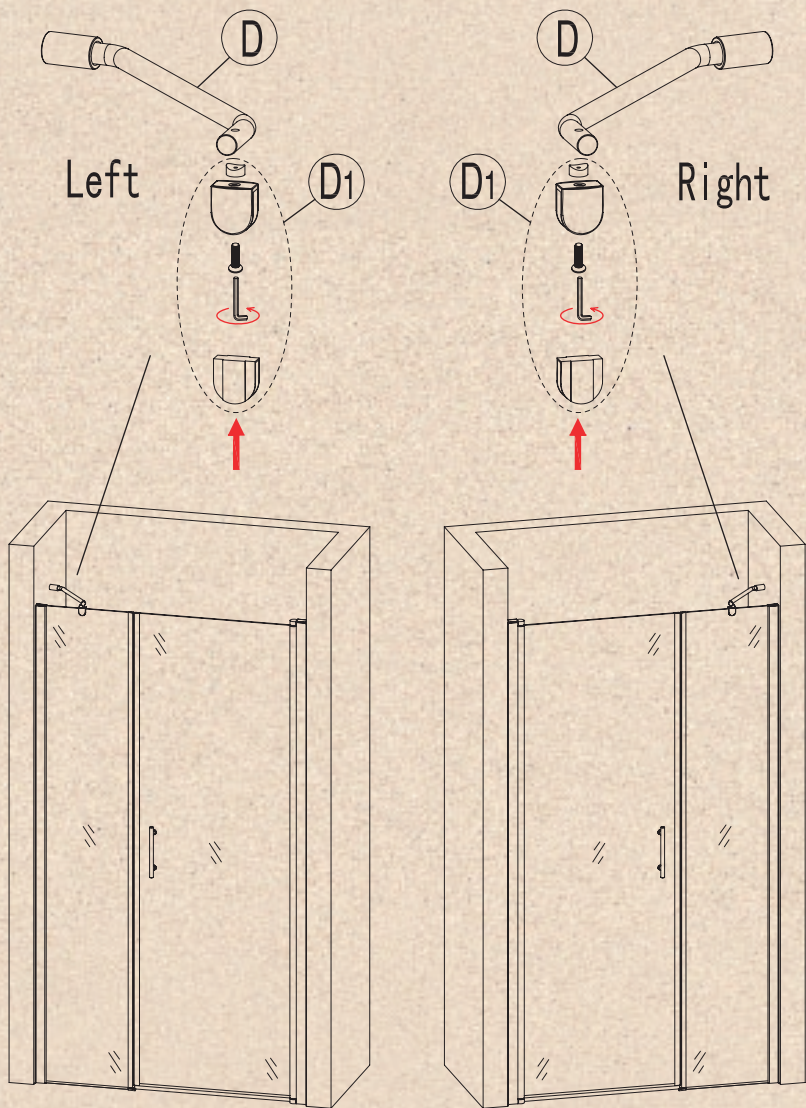

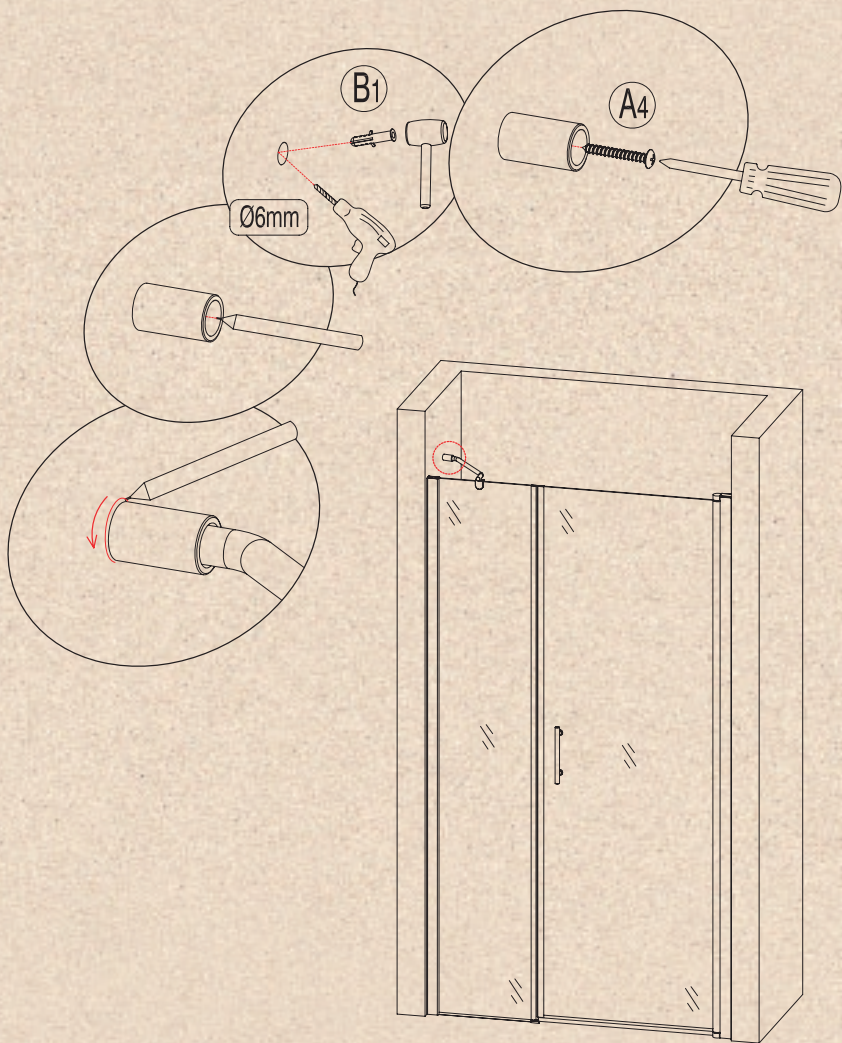

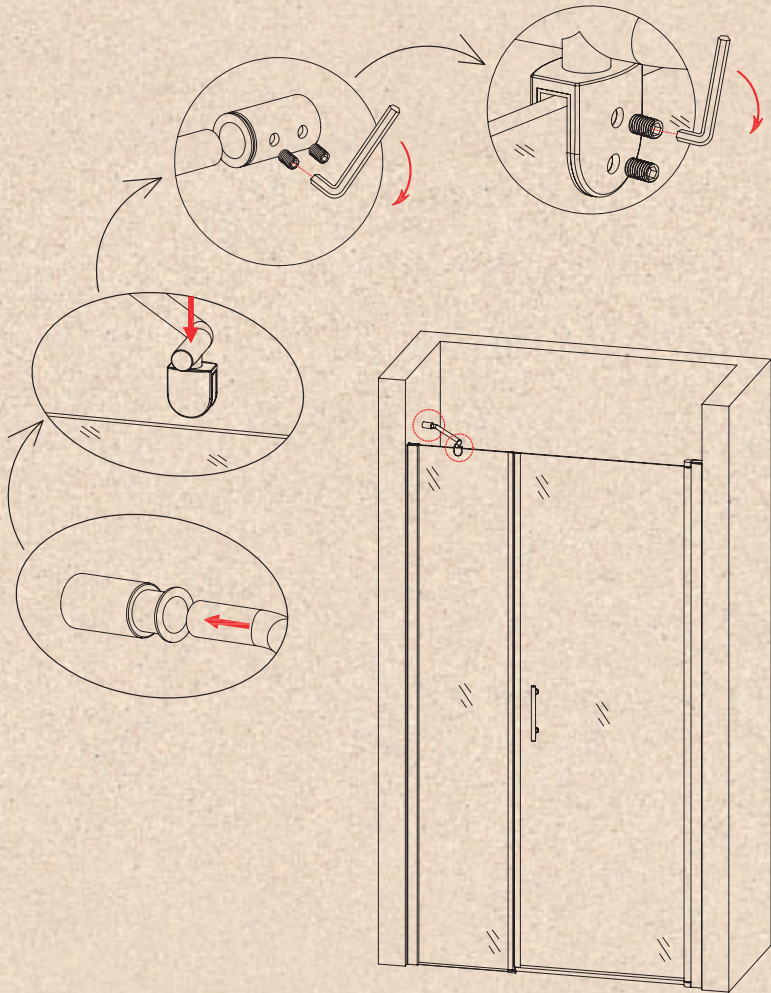

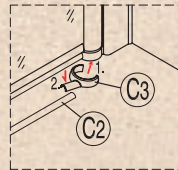
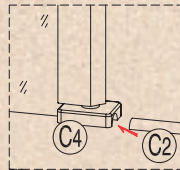
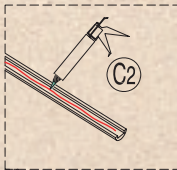
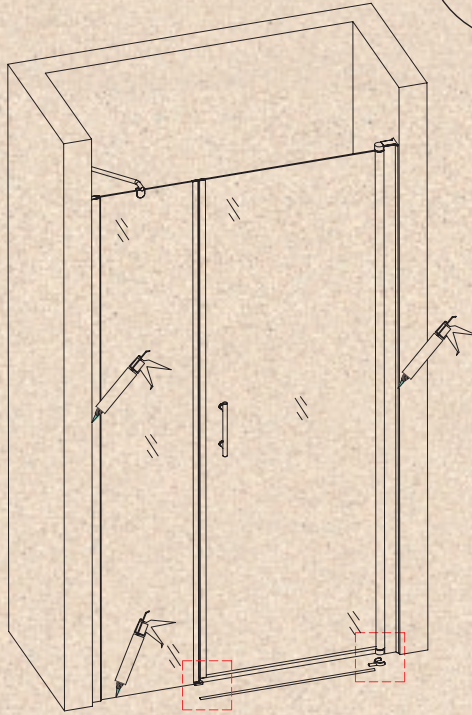

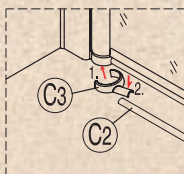
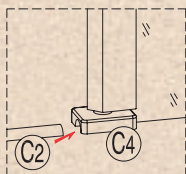
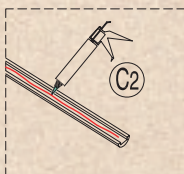
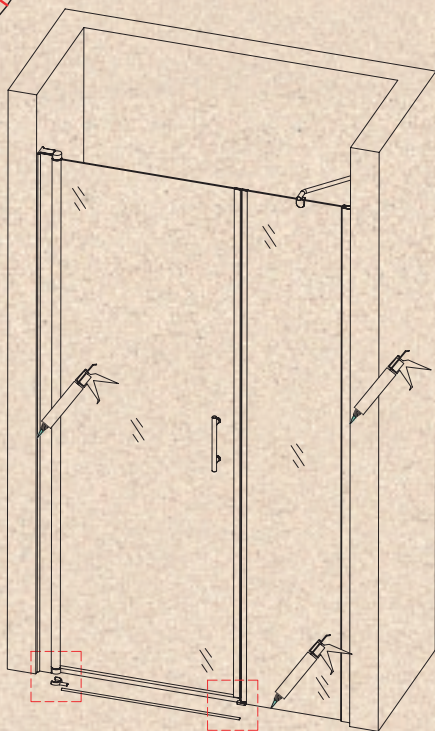



Dział Reklamacji i Serwisu
95-100 Zgierz, ul. Twarda 11/13
tel. (42) 714 30 00, fax (42) 714 30 09
INFOLINIA: 0 800 242 515

Deante Sp. J., Al. Kościuszki 3, 90-418 Łódź
Infolinia: 0 800 242 515
Biuro Obsługi Klienta:
tel.: (42) 714 30 31 do 37, fax: (42) 714 30 30
e-mail: sprzedaz@deante.pl, www.deante.pl